

# Temblor® T10

Active Studio Subwoofer

Owner's Manual

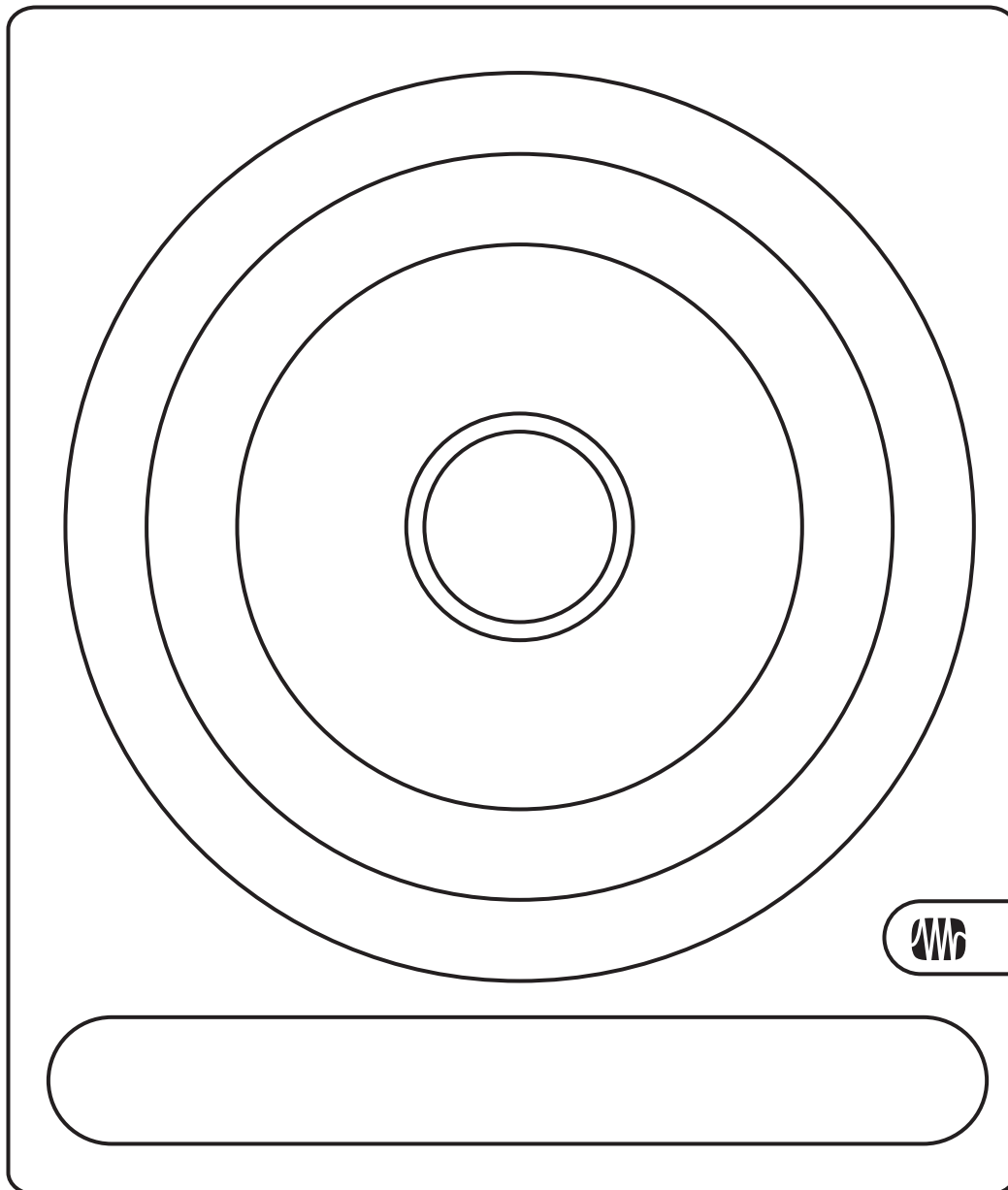

English

Español

Deutsch

Français



# Table of Contents

## **1 Overview — 1**

- 1.1 Introduction — 1
- 1.2 Summary of Temblor T10 Features — 2
- 1.3 What is in the box — 2

## **2 Hookup — 3**

- 2.1 Rear-Panel Connections and Controls — 3
  - 2.1.1 Inputs — 3
  - 2.1.2 Outputs — 3
  - 2.1.3 Power — 4
  - 2.1.4 User Controls — 4
- 2.2 Hookup Diagrams — 5
  - 2.2.1 Basic Setup — 5
  - 2.2.2 Advanced Setup — 6

## **3 Tutorials — 8**

- 3.1 Subwoofer Placement — 8
- 3.2 Level Calibration — 8

## **4 Resources — 11**

- 4.1 Technical Specifications — 11
- 4.2 Block Diagram — 12
- 4.3 Troubleshooting — 13



## 1 Overview

### 1.1 Introduction

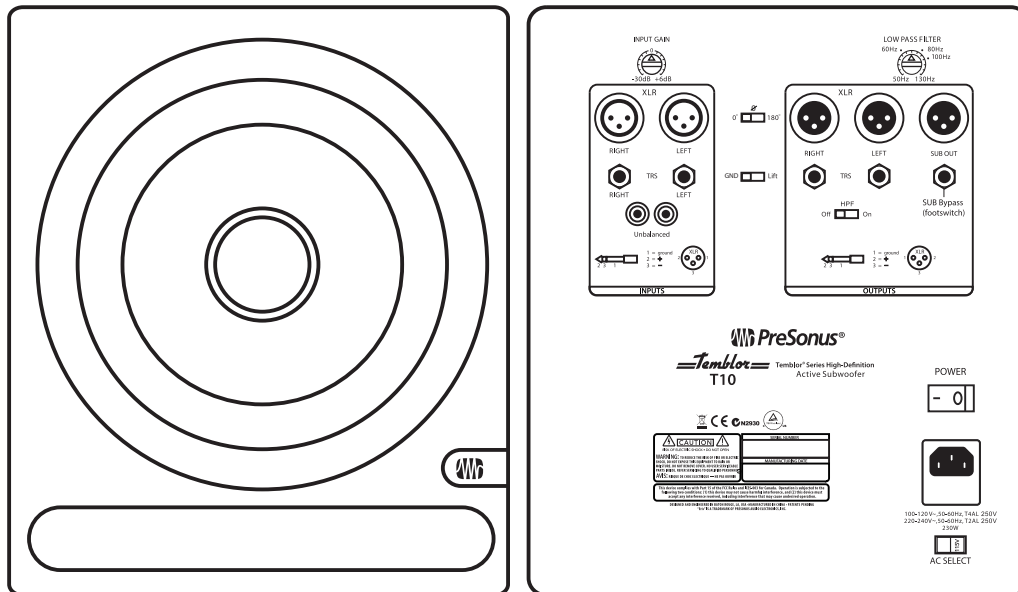

**Thank you** for purchasing the PreSonus® Temblor® T10 active studio subwoofer. PreSonus Audio Electronics has designed the T10 utilizing high-grade components to ensure optimum performance that will last.

The Temblor T10 is an active subwoofer with a 10-inch glass-composite driver, high-temperature voice coil, and damped rubber surround in a ported cabinet, which allows the subwoofer to produce higher volume—up to 113 dB SPL—with less power than a sealed-box design. Featuring a variable (50 to 130 Hz) lowpass filter, the Temblor T10 can be dialed in to pair perfectly with full-range studio monitors, making it the ideal solution for any 2.1 system. The included latching footswitch lets you bypass the sub altogether, making comparing your mix with or without sub frequencies quick and easy. You can even cascade two Temblor T10s together for more and smoother bass.

We encourage you to contact us at 1-225-216-7887 (9 a.m. to 5 p.m. Central Time) with questions or comments regarding your PreSonus Temblor T10. PreSonus Audio Electronics is committed to constant product improvement, and we value your suggestions highly. We believe the best way to achieve our goal of constant product improvement is by listening to the real experts: our valued customers. We appreciate the support you have shown us through the purchase of this product and are confident that you will enjoy your Temblor T10!

**ABOUT THIS MANUAL:** We suggest that you use this manual to familiarize yourself with the features, applications, and correct connection procedures for your Temblor T10 before connecting it to the rest of your studio gear. This will help you avoid problems during installation and setup.

In addition to all the basic info you'll need to connect and operate your Temblor T10, this manual also provides several tutorials that cover subwoofer placement, connections, and calibration.

## 1.2 Summary of Temblor T10 Features

- Active subwoofer with 250 watt, Class AB amplifier
- 10-inch glass-composite woofer with high-temperature voice coil and damped rubber surround
- Frequency response: 20-200 Hz
- Variable lowpass filter control: 50-130 Hz
- 80 Hz highpass filter (with defeat switch) for satellite connections
- Sub/HPF bypass with footswitch control
- Footswitch with cable included
- Front-ported cabinet
- Metal-mesh grille to protect driver

## 1.3 What is in the box

In addition to this manual, your Temblor T10 package contains the following:

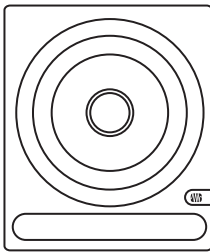

- (1) PreSonus Temblor T10 powered subwoofer

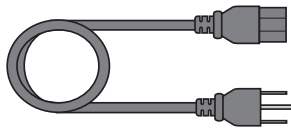

- (1) IEC power cable

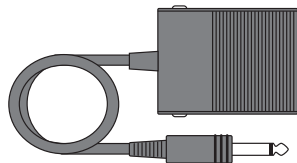

- (1) Footswitch with cable

## 2 Hookup

### 2.1 Rear-Panel Connections and Controls

#### 2.1.1 Inputs

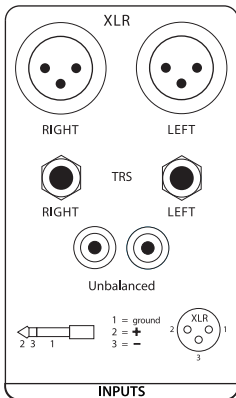

**Line-level Inputs:** The Temblor T10 provides a choice of three input pairs: two sets of balanced inputs (XLR and 1/4" TRS) and one pair of RCA unbalanced inputs. When both of the balanced connections are in use, the TRS inputs will take precedence over the XLR inputs. The RCA inputs will sum into either balanced connection.

**Power User Tip:** Connect both the left and right inputs if you are using the onboard crossover in your Temblor T10 to connect your full-range monitors or if you're running your Temblor T10 independently from a stereo source (such as the Monitor Station or Central Station). This will ensure that your Temblor T10 receives the low-frequency content from both channels. If your audio source provides a mono or LFE output, you only need to connect one input—either L or R.

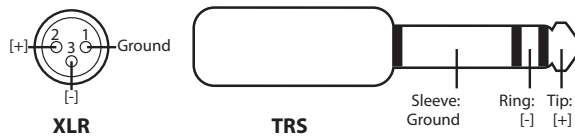

**Input Gain:** Sets the level of the input signal before it is amplified.

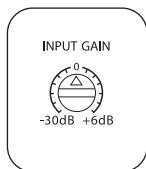

#### 2.1.2 Outputs

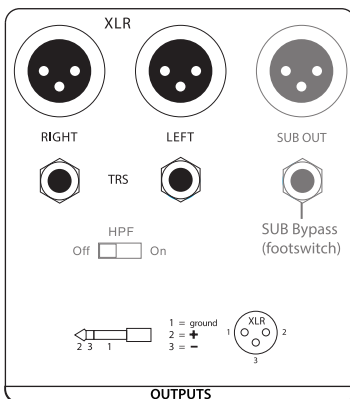

**Outputs:** The Temblor T10 provides two pairs of balanced outputs: XLR and 1/4" TRS. The full-range signal connected to the stereo inputs on the T10 is passed through to these outputs. Use these outputs to connect your main left and right studio monitors. If the High Pass Filter switch is engaged, frequencies below 80 Hz are not sent from these outputs.



**Sub Out:** This XLR Output sends the summed full-range input signal to a second Temblor T10. When connecting a second T10 to this output, set its Low Pass Filter control to the same setting as the first.

### 2.1.3 Power

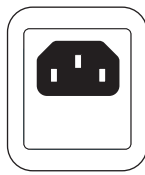

**IEC Power Connection:** Your Temblor T10 accepts a standard IEC power cord.

**Warning:** Do not remove the center grounding prong or use a separate ground-lift adapter, as this could result in electric shock.

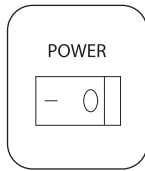

**Power Switch:** This is the On/Off switch. The power status is indicated by the illuminated logo on the front of the cabinet.

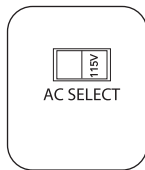

**AC Select Switch:** The input-power voltage is set at the factory to correspond with the country to which it was shipped. Use this switch only if you are using your Temblor T10 in a country that uses a different standard voltage than is used in the country where you purchased your T10.

### 2.1.4 User Controls

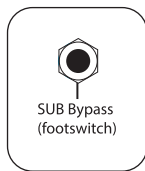

**Sub Bypass:** Connect the bypass footswitch cable to this 1/4" input. Stepping on the footswitch will bypass the subwoofer, highpass filter, and Sub Out altogether. This will allow the signal from your audio source to pass directly through your Temblor T10 to your full-range studio monitors and allow you to compare your mix without subharmonic frequencies. While bypass is active, the LED on the front of your T10 will flash between red and blue. The footswitch is latching, so the bypass remains in effect until you step on it again.

**Power User Tip:** The T10's Sub Bypass function is a convenient way to make sure your mix will sound good on systems with and without a subwoofer. Bypassing the subwoofer will let you hear how the mix sounds without it. After all, many listeners will be using two speakers without a sub, and you want your mix to sound just as good in a stereo system!

**Polarity:** The Polarity button reverses the polarity of the summed input signal.

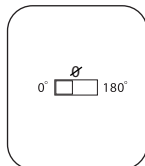

**High Pass Filter:** Removes frequency content below 80 Hz from the full-range signal sent from the T10 outputs. This is useful if your main studio monitors do not have their own highpass filter. The highpass filter is also bypassed when the Sub Bypass is enabled.

**Power User Tip:** Leaving frequency content below 80 Hz in full-range studio monitors can introduce destructive cancellations with the highest frequencies that are reproduced by the Temblor T10. Conversely, this can reinforce these frequencies and make your mix seem to have more bass in it than it actually does. By rolling off your full-range speakers, you will create a more linear frequency response between the subwoofer and full-range content.

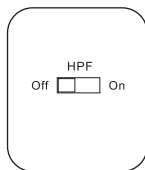

**Low Pass Filter:** This control determines the upper end of the frequency range reproduced by the Temblor T10. If you have enabled the onboard highpass filter, set the Low Pass Filter control to the same value. Otherwise, set the Low Pass Filter control to the lowest frequency that your main studio monitors can reliably reproduce.

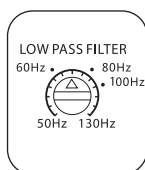



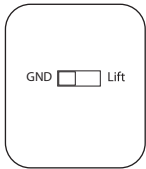

**Ground Lift Switch:** In the “Lift” position, this switch adds 1 kΩ resistance to the ground for the balanced inputs. The Ground Lift switch doesn’t affect the AC mains safety ground for the power supply.

**Power User Tip:** Enabling the ground lift can help to reduce ground loop noise in your audio system. Ground loops can be caused by running audio cables with power cables, by older buildings with improper wiring, or by equipment that generates a lot of RFI, such as computers, laptop power supplies, and the like.

## 2.2 Hookup Diagrams

### 2.2.1 Basic Setup

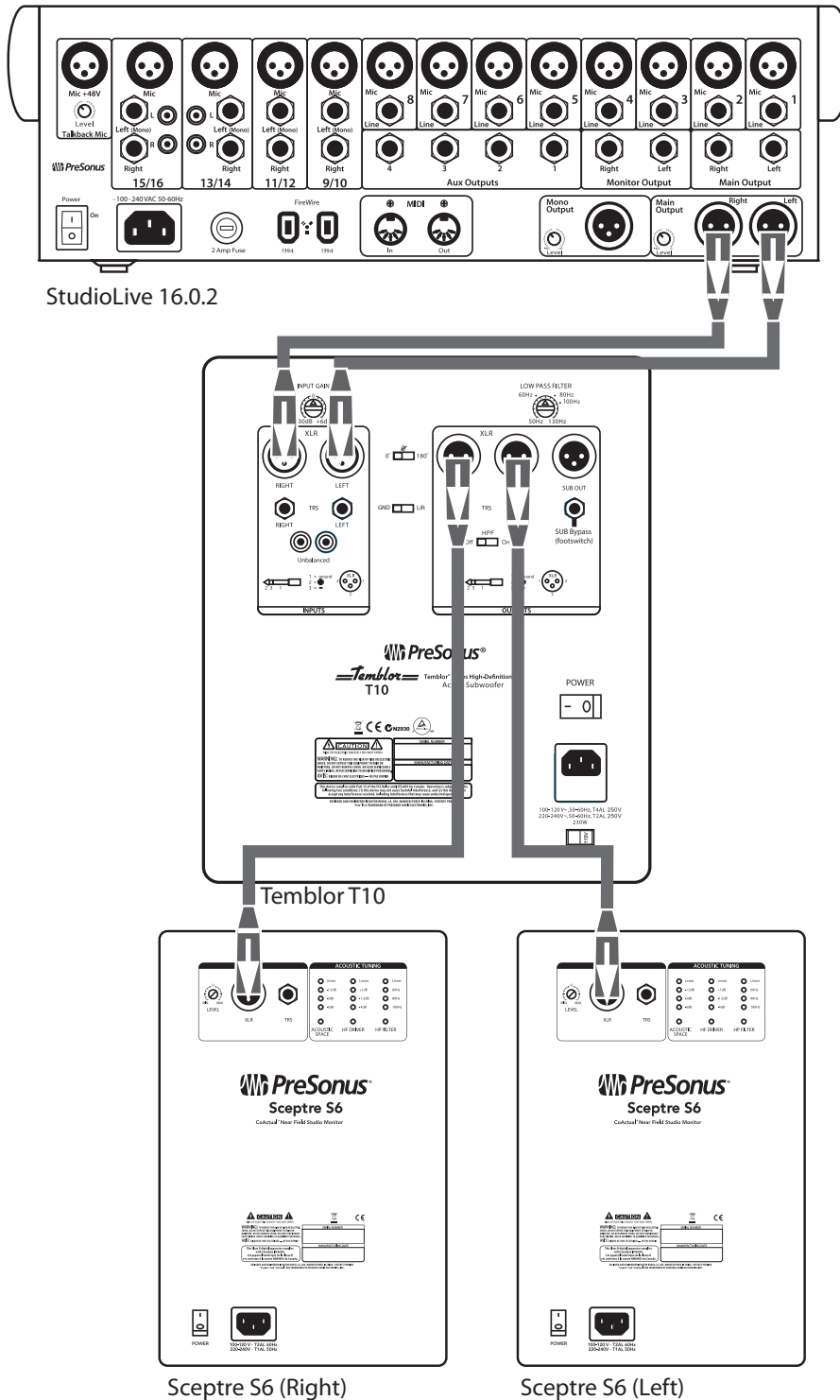

2.2.2 Advanced Setup

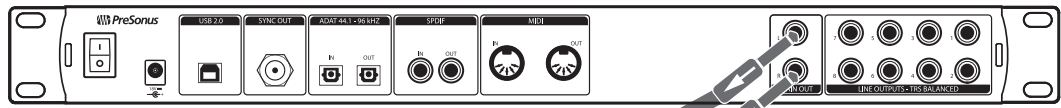

AudioBox 1818VSL

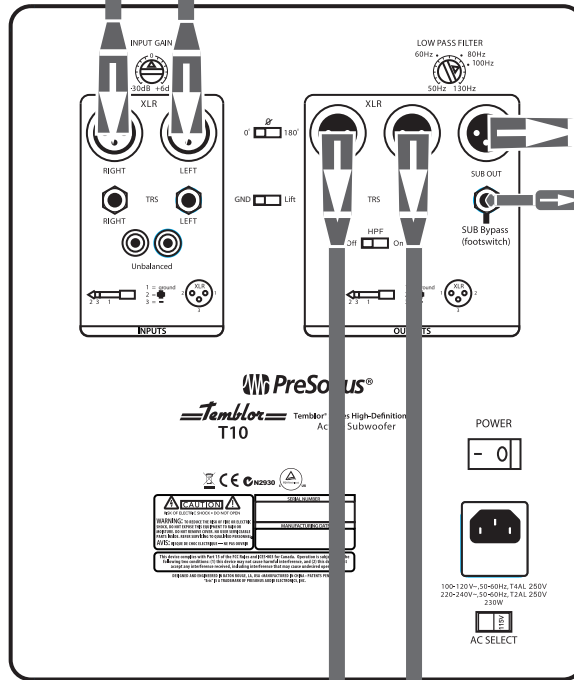

Temblo T10 (Master)

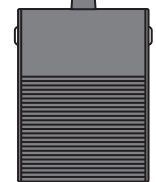

Footswitch

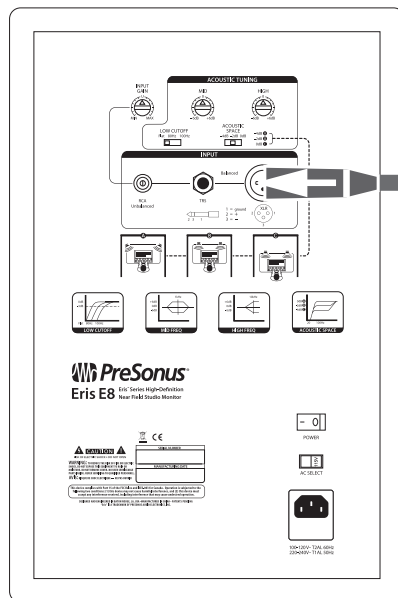

Eris E8 (Right)

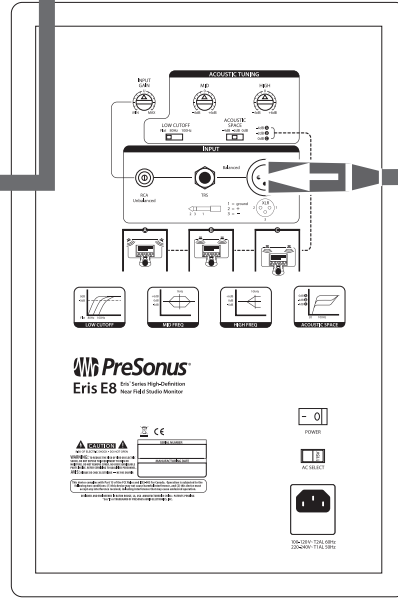

Eris E8 (Left)

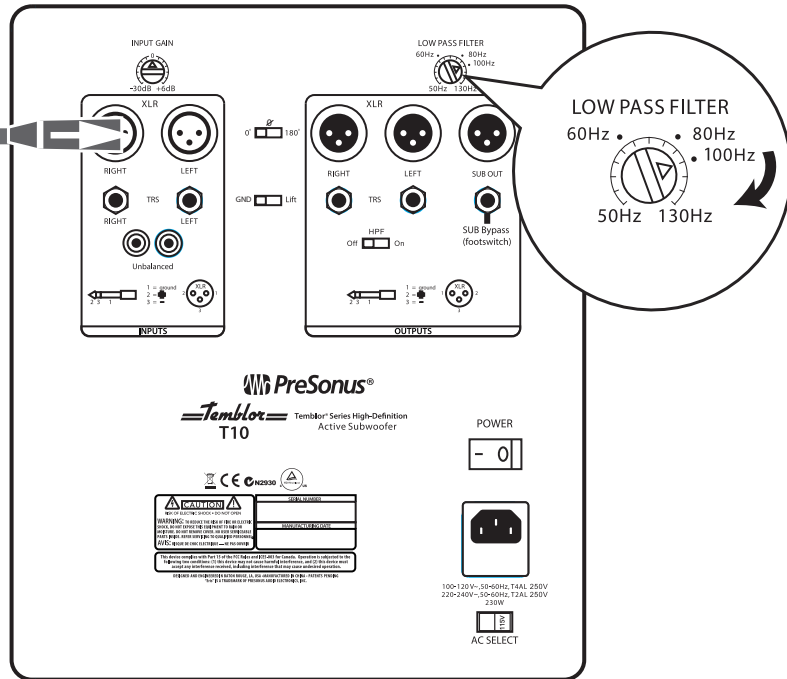

Temblor T10 (Slave)

## 3 Tutorials

### 3.1 Subwoofer Placement

The goal of proper subwoofer placement is to set up your system so that your subwoofer acts as a natural extension of your full-range monitors without boosting the overall bass response of your room or exaggerating any one frequency or frequency range. Because low frequencies are not directional—that is, humans cannot perceive the direction from which low frequencies are coming—you aren't limited to placing it facing the mix position.

A quick way to find the best location for your subwoofer is to temporarily place it in the mix position and play some program material that contains a lot of bass. Move around the half of the room where your full-range monitors are positioned until you find the spot where the bass sounds its best. Again, it's important to remember that low frequencies are not directional, so placing the subwoofer beside or behind you will not be an issue. In general, you will want to avoid placing your subwoofer too near to reflective surfaces, like a wall or in a corner as this will exaggerate the bass energy and make your T10 sound "boomy."

Once you find the place in the room where the bass sounds the smoothest, place your T10 in that spot, return to the mix position and listen to it again. You may need to adjust the location; just keep making small adjustment (a foot or so at a time) until the bass response sounds as even as possible. Don't locate your T10 where it will exaggerate frequencies, as this will have the opposite effect on your mix. For example, if your system has a bump around 100 Hz, what you hear will not accurately reflect what is in your mixes, resulting in less kick-drum punch than you wanted.

### 3.2 Level Calibration

Matching the levels of the all studio monitors in your system is an easy extra step that will help you to achieve an optimal listening environment. You will need an SPL meter to do this; luckily, there are many inexpensive and free SPL meter apps for just about every type of smartphone that will do the job nicely. Below is a brief tutorial on how to level match your monitors. Note: Make sure that any effects processors (such as EQs, compressors, and reverbs) have been bypassed. You'll want a clean signal.

1. Connect your studio monitors and Temblor T10 as shown in the hookup diagram in **Section 2.2.1**.
2. Turn your Temblor T10 and your full-range studio monitors' input levels to their lowest setting.

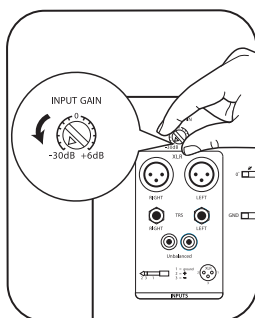
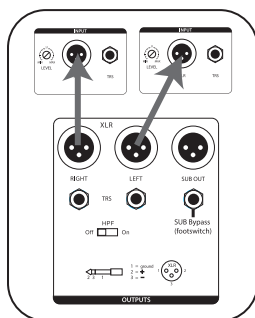

3. Play pink noise through your primary audio source's outputs. You should not hear anything yet.



**Power User Tip:** Some DAW applications, including PreSonus Studio One®, offer a tone generator for this purpose. If you're mixing in a DAW application, use the built-in tone

generator or load a sample audio file or plug-in. After all, your DAW is the beginning of your mixing environment's signal path!

4. Pan the pink noise so it only plays in the left speaker (hard left).



5. Begin turning up the outputs of your primary audio source to their unity-gain setting. "Unity gain" is the level or setting at which the signal level is neither boosted nor attenuated, and it is usually marked by a "U" on the audio device's level fader or knob. In many digital interfaces and other digital devices, the device's maximum level is also its unity-gain setting. Please consult your audio device's user manual or the manufacturer's Web site for more information on its levels and adjustments.

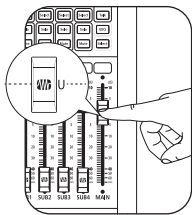

6. Begin slowly increasing the input sensitivity (volume) of your left studio monitor until the acoustic level of the pink noise reaches 82 dB SPL on your SPL meter when measured at your mix position.

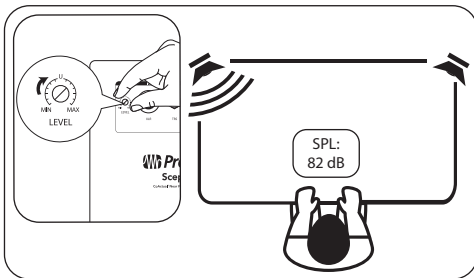

7. Pan the pink noise so that it only plays in the right speaker (hard right), and repeat step 6 for the right channel.

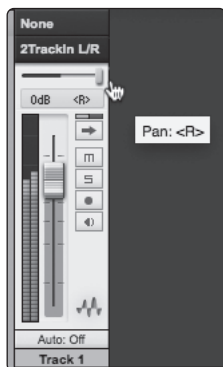



8. Turn your full-range monitors off.

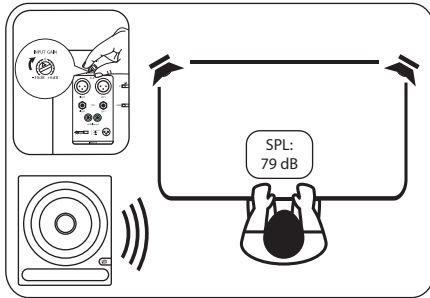

9. Begin slowly increasing the input volume on your Temblor T10 until the acoustic level of the pink noise reaches 79 dB SPL on your SPL meter when measured at mix position.

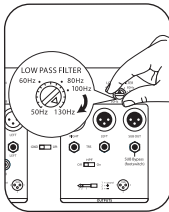

10. Set the lowpass filter on your T10 to 130 Hz. This will create an overlap between your T10s and your full-range system's frequency responses.

11. Play pink noise through your full system and experiment with the polarity switch on your Temblor T10 to see which position provides the best bass response at your mix position. Leave the polarity switch in the position that provided the loudest bass response. This means that you subwoofer is in phase with your full-range system.
12. If you are using the 80 Hz highpass filter on the T10 to bandpass your full-range monitors, set the lowpass filter to 80 Hz. If you are using an external highpass filter for your full-range monitors, set the lowpass filter to the appropriate frequency (e.g., if your highpass filter is set to 100 Hz, set the lowpass filter to the same frequency). You may need to experiment with the Low Pass Filter setting on your subwoofer until you find the smoothest crossover position.

Once the Input Gain control is set on your full-range monitors and T10, leave it alone; don't use it as a volume control. Leave that job to your audio device's output-level control.

## 4 Resources

### 4.1 Technical Specifications

#### INPUTS

	2- Balanced XLR
	2- Balanced ¼" TRS
	2- Unbalanced RCA

#### OUTPUTS

	2- Balanced XLR (full range with 80 Hz HPF option)
	2- Balanced ¼" TRS (full range with 80 Hz HPF option)
	1- Balanced XLR (Sub Out)

#### PERFORMANCE

Frequency Response	20 Hz – 200 Hz
Low Pass Filter Frequency	50 – 130 Hz (variable)
Signal-to-Noise Ratio	>98 dB
THD	0.019% @ power <160W
Amplifier Power	170W RMS / 250W Peak
Power Consumption	230W
Amplifier Type	Class AB
Peak SPL at 1m	113 dB
Woofer	10" glass-composite

#### USER CONTROLS

Input Gain Control	-30 to +6 dB
Polarity Switch	0° or 180°
Low Pass Filter Control	50 Hz to 130 Hz
Ground Lift Switch	On/Off
High Pass Filter Switch	On/Off
Bypass Footswitch	On/Off

#### PROTECTION

	RF interference
	Output-current limiting
	Over-temperature
	Turn-on/off transient
	Subsonic filter
	External mains fuse

**POWER**

100-120V ~50/60 Hz or 220-240V ~50/60 Hz

**CABINET**

Vinyl-laminated MDF

**PHYSICAL**

Width	12.60" (320 mm)
Depth	15.75" (400 mm)
Height	15.75" (400 mm)
Weight	39.46 lbs (17.9 kg)

**4.2 Block Diagram**

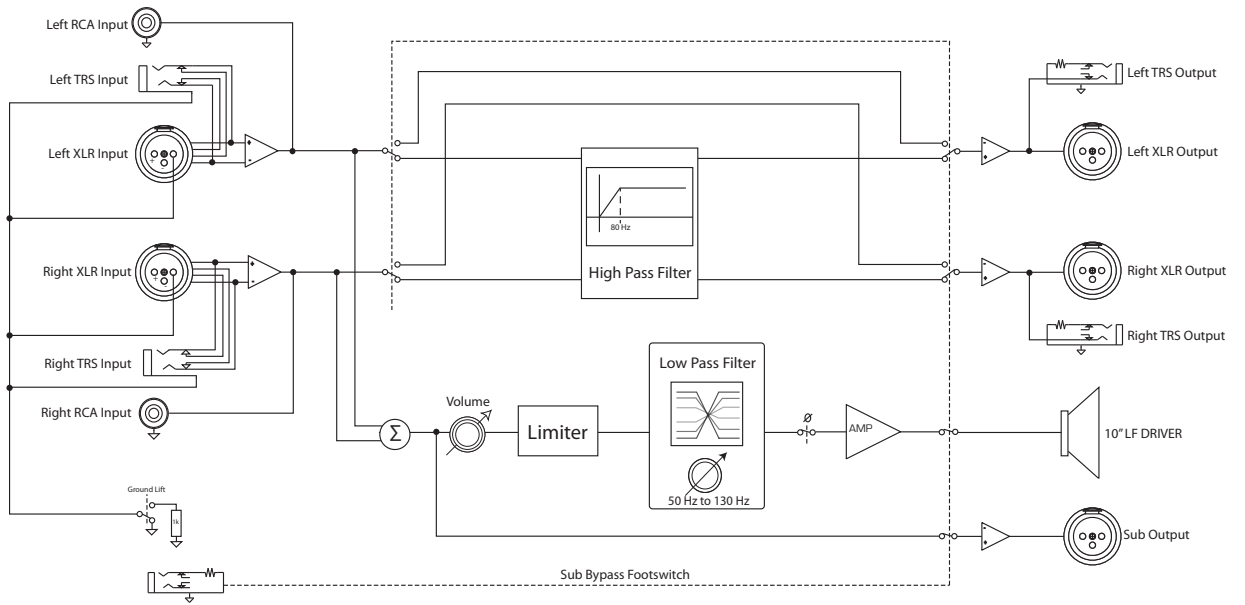



## 4.3 Troubleshooting

**No power.** First ensure that your Temblor T10 is plugged in. If it's connected to a power conditioner, verify that the power conditioner is turned on and functioning. If it is, yet there is still no power to the monitor, contact PreSonus for a repair.

**No audio.** If your Temblor T10 appears to power on but you hear no sound when playing audio from the mixer (the lights are on but nobody's home), first make sure that the cables connecting the mixer to the subwoofer are working correctly. Also, verify that the Input Gain control is set to provide enough amplitude for the signal.

**Hum.** Usually, hum is caused by a ground loop. Verify that all audio equipment is connected to the same power source. If you are not using a power conditioner, we highly recommend that you add one. Not only will this help to minimize hum, it will better protect your equipment from power surges, brownouts, etc.

Try setting the Ground Lift switch to "Lift." This adds 1 k $\Omega$  resistance to the ground of the balanced inputs and often eliminates hum.

Use balanced cables whenever possible. If your audio device does not offer a balanced output, you can connect it to the unbalanced RCA inputs on the Temblor T10, or you can connect it to a DI (direct-injection) box, which will provide a ground-lift switch and a balanced output.

Finally, make sure that your audio cables are not run near power cables, and use cables that are the appropriate length for your application. Using cables that are too long not only increases the risk of noise, it increases the likelihood that the cables are coiled, which will essentially create an antenna that picks up all kinds of audio interference.



## Added bonus: PreSonus' previously Top Secret recipe for...

# Rice Dressing

### Ingredients:

- 1lb ground beef
- 1 lb chopped chicken liver
- 1 onion (diced)
- 2 green peppers (diced)
- 4-6 celery stalks (diced)
- 2 garlic cloves (minced)
- ¼ C. chopped fresh parsley
- 3 C. chicken stock
- 6 C. cooked rice
- 1 Tbs. oil
- Salt and pepper to taste
- Cayenne pepper to taste

### Cooking Instructions:

1. In a large pot, heat oil on medium high and add meat, salt, and pepper to taste. Stir until meat begins to brown.
2. Lower heat and add all vegetables. Cook until onions are transparent and celery is very tender. Add stock as necessary to prevent burning.
3. Stir in cooked rice. Add remaining stock and simmer on low until ready to serve.

# Temblor® T10

## Active Studio Subwoofer

### Owner's Manual

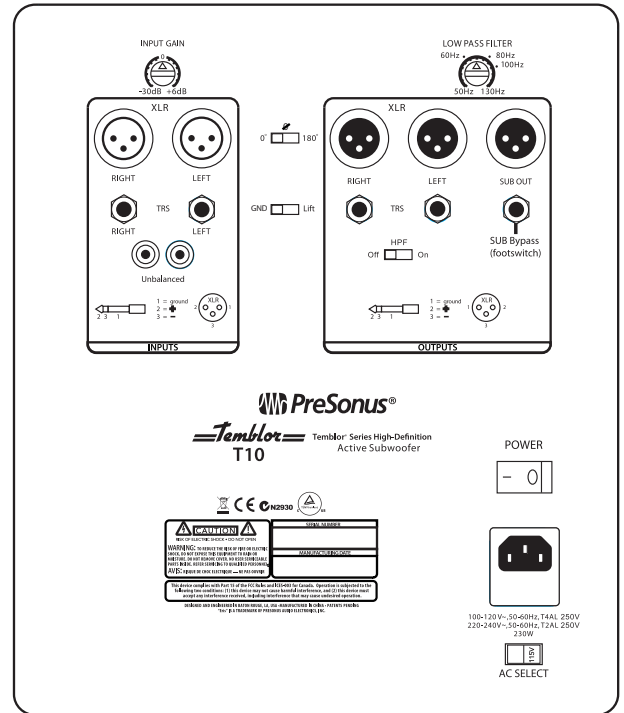
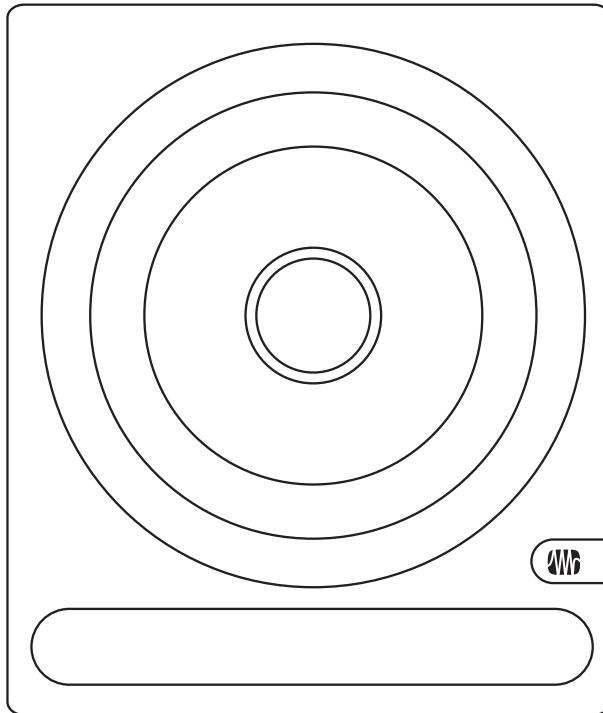

18011 Grand Bay Ct. • Baton Rouge,  
Louisiana 70809 USA • 1-225-216-7887  
[www.presonus.com](http://www.presonus.com)