

Eris®-Series 3.5/3.5BT/4.5BT/5BT Media Reference Monitors

Owner's Manual

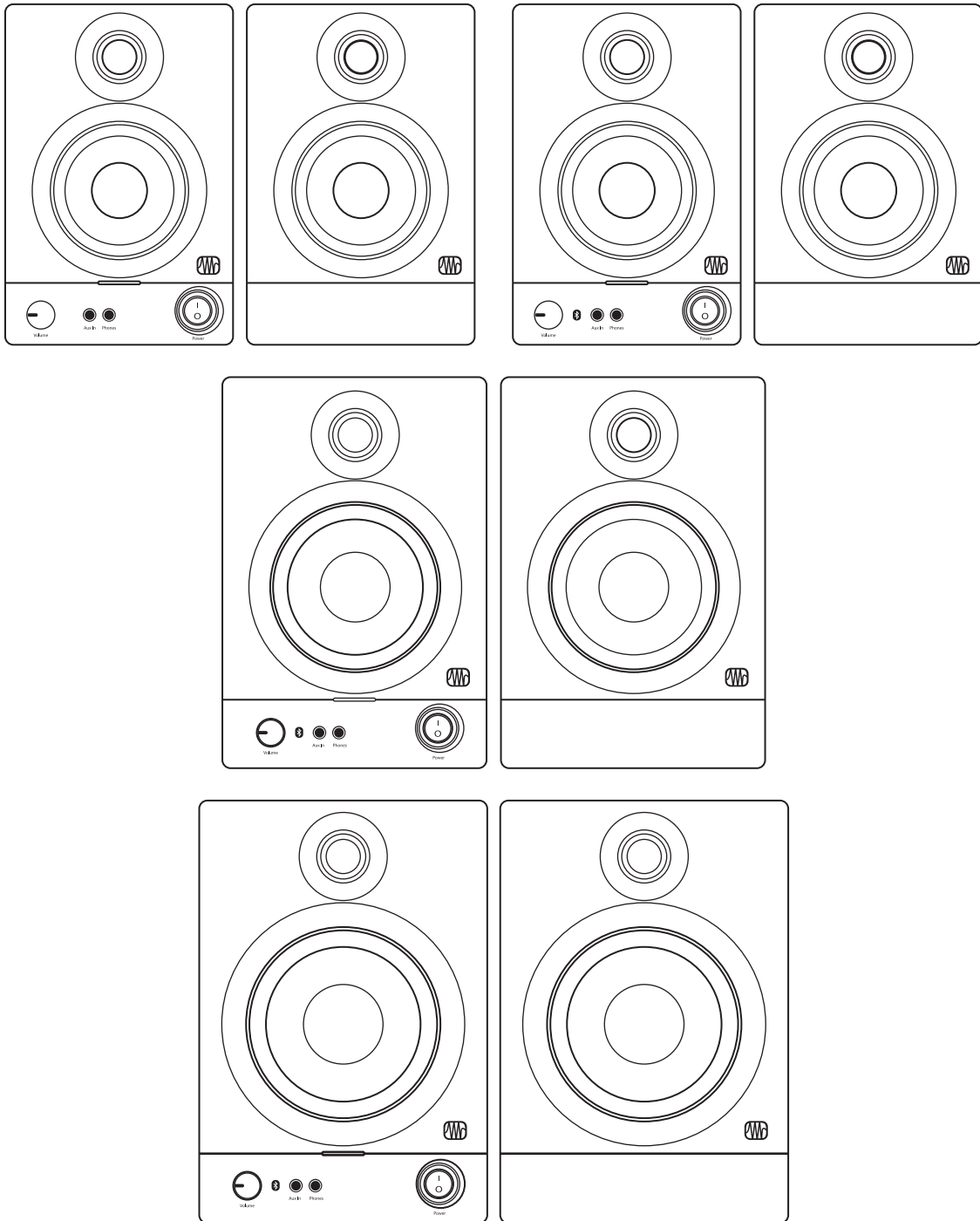

Table of Contents

1 Overview — 1

- 1.1 Introduction — 1
- 1.2 Product Registration — 1
- 1.3 What's in the Box — 2

2 Connections and Controls — 3

- 2.1 Rear Panel — 3
 - 2.1.1 Inputs — 3
 - 2.1.2 Power — 3
 - 2.1.3 Acoustic Tuning Controls — 3
 - 2.1.4 Speaker Connections — 4
- 2.2 Active Speaker Front Panel — 4

3 Hookup Diagrams — 5

- 3.1 Basic Setup — 5
- 3.2 Audio Connections — 5
- 3.3 Bluetooth Pairing (Eris 3.5BT, 4.5BT, and 5BT only) — 6

4 Resources — 7

- 4.1 Technical Specifications — 7
- 4.2 Setting up your Eris Monitors for Best Performance — 7
- 4.3 Troubleshooting — 8

1 Overview

1.1 Introduction

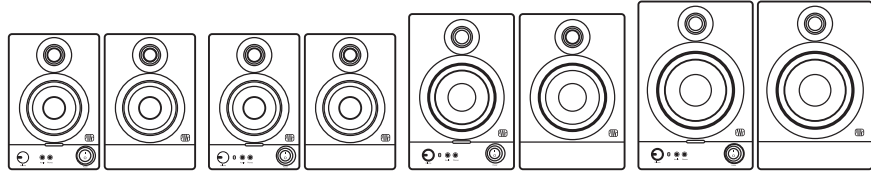

Thank you for purchasing a pair of PreSonus® Eris®-Series media reference monitors. Ideal for gaming, home content creation, or just listening to your favorite album, Eris media reference monitors deliver studio-quality sound, with a smooth and accurate frequency response.

PreSonus Audio Electronics is committed to constant product improvement, and we highly value your suggestions. We believe the best way to achieve our goal is by listening to the real experts: our valued customers. We appreciate the support you have shown us through the purchase of this product and are confident that you will enjoy your Eris!

About this manual: We suggest that you use this manual to familiarize yourself with the features, applications, and correct connection procedures for your Eris media reference monitors before trying to connect it to your other audio equipment. This will help you avoid problems during installation and setup.

This manual describes the functionality for all four Eris media reference models. Please note that Bluetooth connectivity is only available on the Eris 3.5BT, Eris 4.5BT, and Eris 5BT.

Throughout this manual, you will find *Power User Tips* that can quickly make you an Eris expert and help you get the most out of your investment.

1.2 Product Registration

PreSonus is committed to delivering the best experience for our customers. MyPreSonus is a one-stop portal for all our registered customers' needs. From your MyPreSonus account, you can view all your PreSonus hardware and software registrations; contact support; track orders and more.

To register your Eris media reference monitors, go to [My.PreSonus.com](https://www.presonus.com) and follow the onscreen instructions.

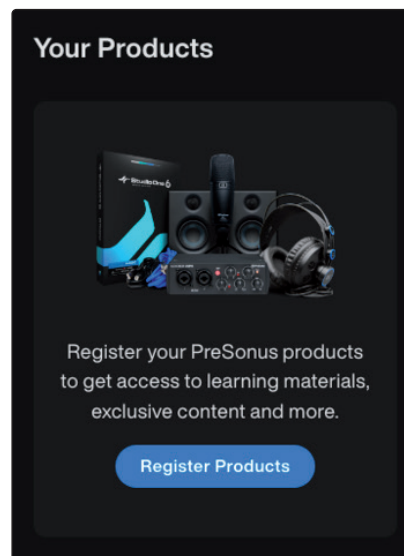

OR

Download the **MyPreSonus** app from the Apple App Store or Google Play.



1.3 What's in the Box

Your Eris media reference monitors' package contains the following:

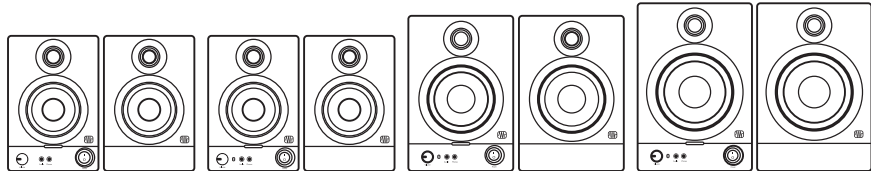

(1 pair) PreSonus Eris Media Reference Monitors (1 active, 1 passive)

(1) 1.5M 1/8" TRS to 2x RCA cable

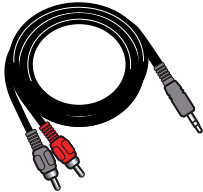

(1) 1.5M 1/8" TRS stereo cable

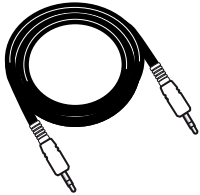

(1) 2M bare-wire speaker cable

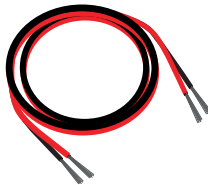

(8) Foam feet: 4 to be placed on the bottom of each speaker to improve isolation

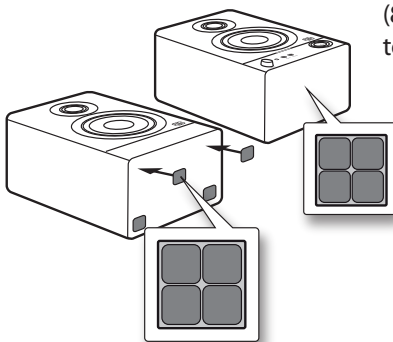

(1) Quick Start Guide



(1) IEC Power Cable



2 Connections and Controls

Each Eris media reference monitor pair consists of one active speaker and one passive speaker. Nearly every connection is located exclusively on the active speaker. This speaker provides signal and power for the passive speaker. The exceptions are the bare-wire connectors, which send power and signal from the active speaker to the passive speaker.

2.1 Rear Panel

2.1.1 Inputs

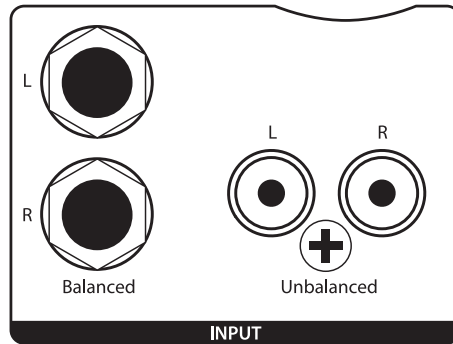

Line-level Inputs. The Eris active speaker provides a choice of two pairs of inputs on the rear-panel: left and right balanced 1/4" TRS and left and right unbalanced RCA. These inputs accept a line-level signal from an audio source and feed that signal to each monitor's power amplifier. These inputs are provided to enable flexible connectivity, not for connecting multiple sources to your speakers simultaneously. A third 1/8" stereo input is available on the front panel, *please see Section 2.2 for more information.*

Power User Tip: The left inputs (balanced or unbalanced) send signal to the amplifier that powers the active speaker; and the right inputs send signal to the amplifier that powers the passive speaker. PreSonus recommends that the active speaker be placed on the left side of your mixing space and the passive speaker be placed on the right. However, if you prefer to have the controls located on your active monitor placed on the right side of your workspace, be sure to reverse the inputs from your audio source to maintain the correct stereo image.

2.1.2 Power



IEC Power Connection. The Eris active speaker accepts a standard IEC C7 power cord. The power switch is located on the front panel of the active speaker.

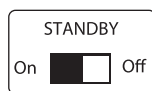

Standby. When standby is engaged, Eris monitors go into power save mode when there is no audio playing for more than 40 minutes. Once audio resumes, the power save mode turns off.

2.1.3 Acoustic Tuning Controls

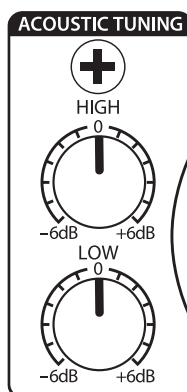

High. Boosts or cuts all frequencies above 10 kHz by ± 6 dB.

Power User Tip: The High control is a high-shelf EQ and attenuates or boosts frequencies above 10 kHz. This EQ is much like the treble control on a home or car stereo: It raises or lowers the gain on all frequencies above the specified cutoff frequency. Shelving EQs can make big changes to the sound very quickly by adding or removing an entire range of frequencies.

Low. Boosts or cuts frequencies around 100 Hz by ± 6 dB.

Power User Tip: The Low control is a low-shelf EQ and attenuates or boosts frequencies below 100 Hz. This function is the equivalent to the Bass control on a home or car stereo: It raises or lowers the gain on all frequencies below the specified cutoff frequency. Shelving EQs can make big changes to sound very quickly by adding or removing an entire range of frequencies.

2.1.4 Speaker Connections

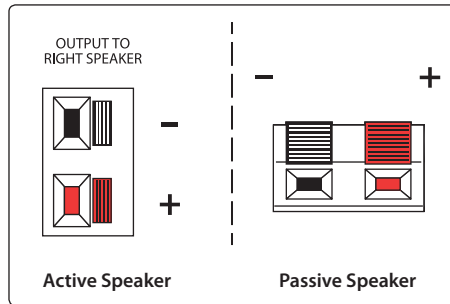

Bare-wire connectors. This connection is used to send power and send signal to the passive Eris speaker. Be sure to connect the positive and negative connections on your active Eris speaker to the positive and negative connections, respectively, on the passive Eris speaker (i.e. connect positive to positive and negative to negative).

2.2 Active Speaker Front Panel

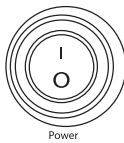

Power Switch. This is the On/Off switch.



Power / Bluetooth Status LED. The LED in the center of the active speaker indicates power status. This LED also displays the Bluetooth status as follows:

- **Solid White:** Eris speaker is powered on and in standby mode.
- **Solid Blue:** Eris speaker is powered on and not in standby mode.
- **Flashing Blue and Green (Eris 3.5BT, 4.5BT and 5BT only):** Eris speaker is in pairing mode.
- **Solid Green (Eris 3.5BT, 4.5BT and 5BT only):** Eris speaker is paired to a bluetooth device.

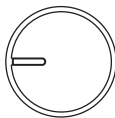

Volume

Volume. Sets the volume level of the input signal before it is amplified. This is also the volume control for the front-panel headphone amp.



Aux In

Aux In. This stereo 1/8" jack can be used to patch in a media player for a quick reference check.

Power User Tip: This input will sum with the inputs on the back panel.



Phones

Headphone Out. This headphone output is controlled by the Level knob.

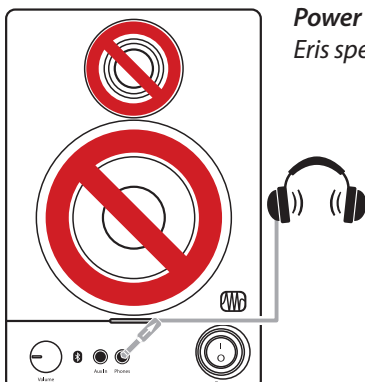

Power User Tip: When the headphone output is connected, audio will be muted to your Eris speakers. So, you can listen as loud as you like without disturbing the neighbors.

3 Hookup Diagrams

3.1 Basic Setup

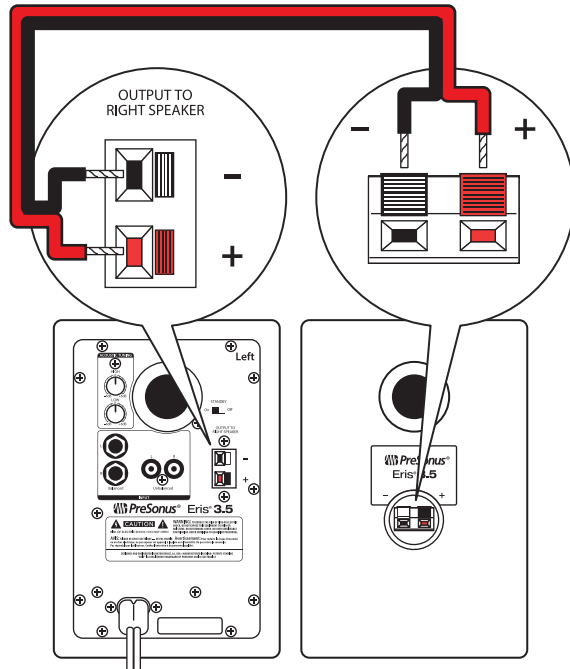

3.2 Audio Connections

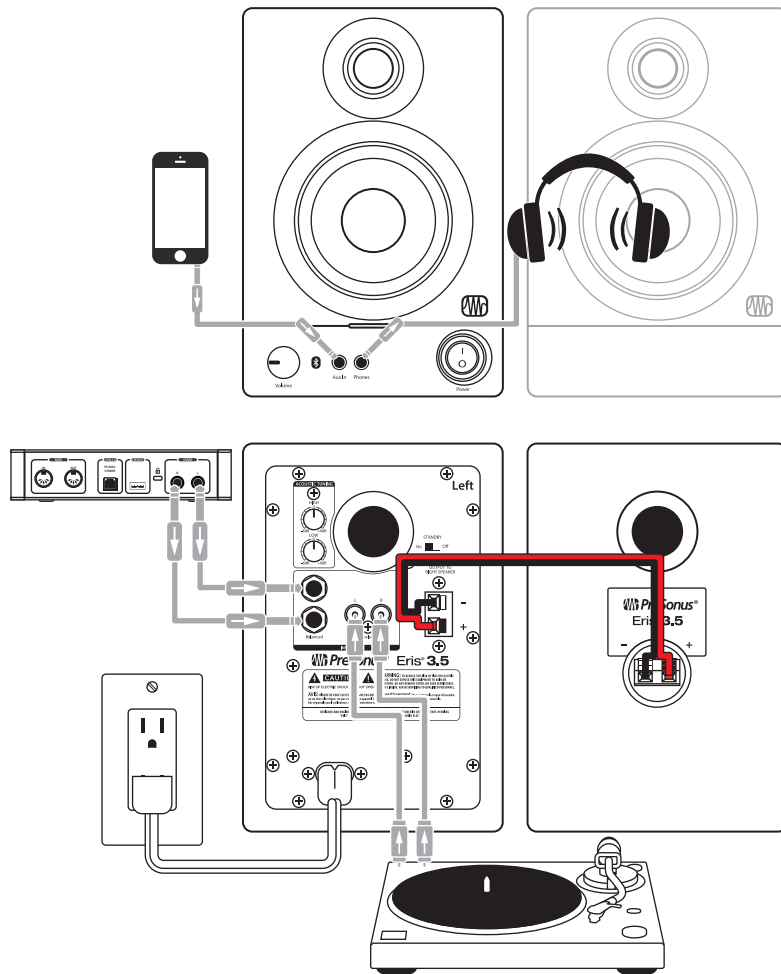

3.3 Bluetooth Pairing (Eris 3.5BT, 4.5BT, and 5BT only)

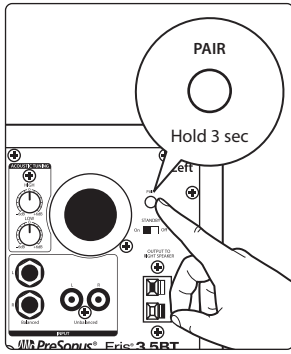

Your Eris 3.5BT, 4.5BT or 5BT can be paired with any Bluetooth device for audio playback. To pair your speakers, first press and hold the pair button on the rear of the active Eris speaker for three seconds.

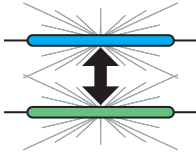

The Power/Bluetooth LED on the front of the active speaker will flash blue and green, indicating pairing is active.

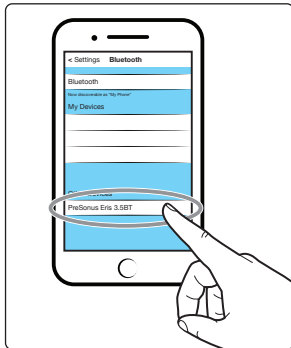

On your Bluetooth device, select "Eris 3.5BT", "Eris 4.5BT" or "Eris 5BT".



Once your Eris speakers are paired, the Power/Bluetooth LED will illuminate green.

Power User Tip: You can pair an additional device by repeating these steps. Your Eris speakers can store two Bluetooth device pairings, although audio can only be streamed from one Bluetooth device at a time. Whenever you power on your Eris speakers, your stored Bluetooth devices will automatically pair if within range.

4 Resources

4.1 Technical Specifications

	3.5	3.5BT	4.5BT	5BT
Frequency Response	80 Hz to 20 kHz	80 Hz to 20 kHz	70 Hz to 20 kHz	55 Hz to 20 kHz
Peak SPL	98 dB (@ 1M)	98 dB (@ 1M)	100 dB (@ 1M)	104 dB (@ 1M)
LF Amplifier Power	25W, Class AB	25W, Class AB	25W, Class AB	50W, Class D
HF Amplifier Power	25W, Class AB	25W, Class AB	25W, Class AB	50W, Class D
LF Driver	3.5-inch woven composite	3.5-inch woven composite	4.5-inch woven composite	5.25-inch woven composite
HF Driver	1-inch, silk-dome	1-inch, silk-dome	1-inch, silk-dome	1-inch, silk-dome
Inputs (1 each)	Balanced ¼-inch TRS Unbalanced RCA 1/8-inch stereo	Balanced ¼-inch TRS Unbalanced RCA Bluetooth 1/8-inch stereo	Balanced ¼-inch TRS Unbalanced RCA Bluetooth 1/8-inch stereo	Balanced ¼-inch TRS Unbalanced RCA Bluetooth 1/8-inch stereo
Controls	Volume High Frequency Low Frequency Power Saver	Volume High Frequency Low Frequency Power Saver	Volume High Frequency Low Frequency Power Saver	Volume High Frequency Low Frequency Power Saver
Dims (H x W x D)	8.27" x 5.53" x 6.46" (210mm x 140.5mm x 164mm)	8.27" x 5.53" x 6.46" (210mm x 140.5mm x 164mm)	9.49" x 6.42" x 7.05" (241mm x 163mm x 179mm)	10.28" x 7.01" x 7.87" (261mm x 178mm x 200mm)
Weight	6.83 lbs (3.1 kg)	6.83 lbs (3.1 kg)	9.91 lbs (4.5 kg)	13.89 lbs (6.3 kg)

4.2 Setting up your Eris Monitors for Best Performance

1. Use balanced cables to connect your monitors to your audio device. A balanced cable is a type of audio cable that uses three conductors (two signal conductors and a ground conductor) to transmit audio signals. Balanced cables help to cancel out any noise or interference picked up along the cable length. Unbalanced cables are more susceptible to noise and interference and should be avoided.
2. Make sure that your monitors are plugged into a good power source. Unstable or noisy power sources can cause unwanted noise in your audio signal. Use a surge protector or power conditioner if necessary.
3. Keep your cables away from power sources and other electronic devices to avoid electromagnetic interference that can cause buzzing, humming, or other noise in your audio signal.
4. Position your monitors correctly to minimize noise. Keep them at a reasonable distance from other electronic devices to avoid interference.
5. Proper gain staging can help you avoid noise in your audio signal. Gain staging refers to the process of setting the input and output levels of audio signals in a recording or mixing system to achieve optimal sound quality and avoid distortion. Make sure that your input levels are not too low or too high. Keep your levels within a reasonable range and avoid overdriving your audio interface or mixer.

4.3 Troubleshooting

No power. First ensure that your active Eris speaker is plugged in. If it's connected to a power conditioner, verify that the power conditioner is turned on and functioning.

No audio. If your active Eris speaker appears to power on but you hear no sound when playing audio from your audio source (the lights are on but nobody's home), first make sure that the cable connecting your audio source to the active speaker is working correctly. Also, verify that the volume control is set to provide enough amplitude for the signal. If only the passive Eris speaker is not passing audio, check your speaker-wire connections and verify that the bare wire is fully inserted into each connection.

Hum. Usually, hum is caused by a ground loop. Verify that all audio equipment is connected to the same power source.

Sound is thin. If the sound of the speakers seems thin and brittle, check that your speaker wires are connected correctly (i.e., the positive/red connection on the active Eris speaker is connected to the positive/red connection on the passive Eris speaker and the negative/black connection on each is connected to the negative/black connection on the other).

Added bonus: PreSonus' previously Top Secret recipe for...

Chicken and Andouille Gumbo

Ingredients:

- 1 C All-Purpose flour
- $\frac{3}{4}$ C Vegetable Oil
- 1 large onion (diced)
- 1 small onion (quartered)
- 6 celery stalks (diced)
- 1 large green bell pepper (diced)
- 3 cloves garlic (2 minced, 1 whole)
- 1 lb link Andouille sausage
- 4 Chicken leg quarters
- 4 qt water
- 4 bay leaves
- 1 tsp thyme
- 1 tsp Old Bay seasoning
- 1-2 C frozen okra, sliced
- $\frac{1}{4}$ C fresh parsley, minced
- 6-8 eggs (optional)

Cooking Instructions:

1. In a large pot, combine whole chicken leg quarters, water, quartered onion, Old Bay, 2 bay leaves and 1 whole clove garlic. Cover and bring to a low boil. Simmer stock until chicken is falling off the bone. Remove the chicken and set aside. Discard the onion, bay leaves, and garlic, reserving the liquid.
2. In a heavy saucepan, heat 1 Tbsp of the oil on medium high heat and brown the andouille until it is cooked through. Set aside sausage for later.
3. In the same saucepan, add and heat remaining oil. Slowly add flour 1-2 Tbsp at a time, stirring continuously. Continue cooking and stirring the roux until it is a dark brown (it should look like melted dark chocolate). Be careful to not to get the oil too hot or the flour will burn and you'll have to start over.
4. Once roux has reached the correct color, add diced onion, celery, green pepper, and minced garlic. Cook until vegetables are very tender. Do not cover.
5. Slowly add 1 quart of chicken broth and bring to a low boil, stirring constantly.
6. Transfer roux mixture to a soup pot and bring to low boil. Do not cover, the roux will settle on the bottom of the pot and burn.
7. Add remaining chicken broth, bay leaves, and thyme. Simmer for 30 minutes.
8. While gumbo is simmering, debone and shred chicken and slice the andouille.
9. Add chicken and andouille to gumbo and return to a simmer. Simmer for 30-45 minutes.
10. Stir in frozen okra and parsley and bring to a rolling boil.
11. **Optional:** Crack one egg into a teacup and quickly pour into the boiling gumbo. Repeat with the other eggs being careful not to cluster them too closely. After all the eggs have risen back to the surface, reduce heat and simmer.
12. Correct seasoning with salt and pepper (red, white and/or black) if necessary.
13. Serve over rice with potato salad.

Serves 12

Eris®-Series 3.5/3.5BT/4.5BT/5BT Media Reference Monitors

Owner's Manual

